



3 GHz SMA LATCHING S.P.D.T. SWITCH

OPTIONS : INDICATOR

R F CHARACTERISTICS

FREQUENCY RANGE : 0 - 3 GHz
 IMPEDANCE : 50 Ohms

FREQUENCY (GHz)	0 - 3
V.S.W.R <=	1.20
INSERT. LOSS <=	0.20 dB
ISOLATION >=	80 dB
AVER. POWER (*)	240 W

ELECTRICAL CHARACTERISTICS

ACTUATOR : LATCHING
 NOMINAL CURRENT AT 25° C (±10%) : 80 mA
 ACTUATOR VOLTAGE (Vcc) : 28V (24 to 30V) / POSITIVE COMMON
 TERMINALS : solder pins (250° C max./30 sec.)
 INDICATOR RATING : 1 W / 30 V / 100 mA

MECHANICAL CHARACTERISTICS

CONNECTORS : SMA fem. per MIL C 39012
 LIFE : 10.000000 cycles
 SWITCHING TIME (nominal voltage;25° C) : < 10 ms
 CONSTRUCTION : splashproof
 WEIGHT : < 45 g

ENVIRONMENTAL CHARACTERISTICS

OPERATING TEMPERATURE RANGE (°C) : -40 , +85
 STORAGE TEMPERATURE RANGE (°C) : -55 , +85

(* : average power at 25° C)

4112-9212 This information is given as an indication. In the continual goal to improve our products, we reserve the right to make any modifications judged necessary

DRAWING

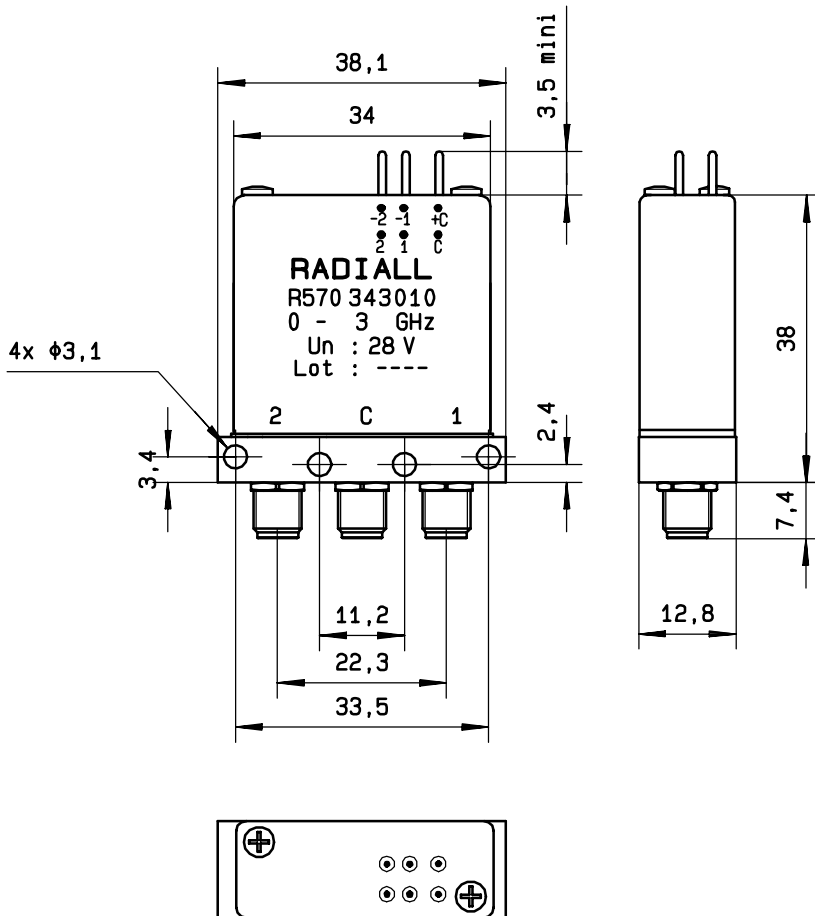

General tolerance: $\pm 0,5$ mm

SCHEMATIC DIAGRAM

Voltage	RF continuity	Indicator
+ C - 1	C \leftrightarrow 1	C . 1
+ C - 2	C \leftrightarrow 2	C . 2

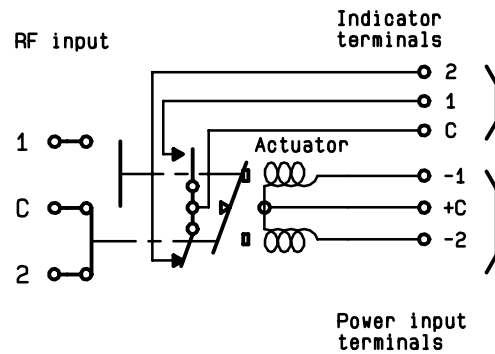

4113-9212 This information is given as an indication. In the continual goal to improve our products, we reserve the right to make any modifications judged necessary